

Cilindri Serie 40

Doppio effetto, ammortizzati, magnetici
Ø 160 - 200 - 250 - 320 mm



1

MOVIMENTO

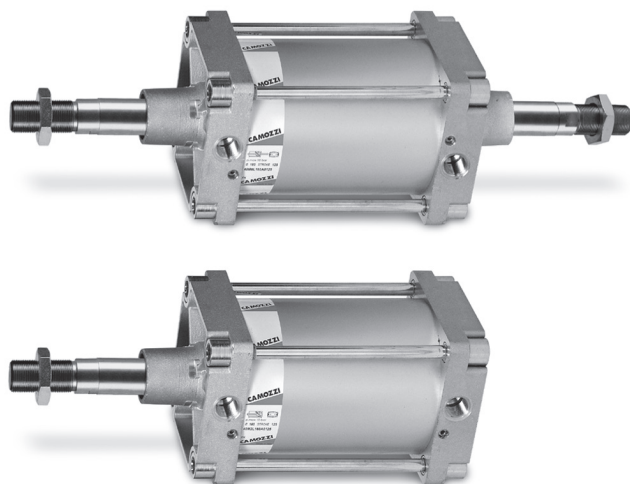

- » Conformi alla normativa ISO 15552 e alle precedenti DIN/ISO 6431 - VDMA 24562
- » Ammortizzatore pneumatico regolabile
- » Stelo in acciaio INOX rullato (Ø 160 - 200 mm)
- » Stelo in acciaio cromato (Ø 250 - 320 mm)
- » Anello raschiastelo in ottone

I cilindri della Serie 40 sono stati realizzati rispettando gli ingombri della norma ISO 15552 e delle precedenti ISO 6431/VDMA 24562. Sul pistone di questi cilindri è alloggiato un magnete permanente che rende possibile, attraverso dei sensori disposti lungo l'asse di scorrimento dello stelo, l'emissione di segnali elettrici che ne indicano la posizione.

Questa serie di cilindri è normalmente fornita con ammortizzatori di fine corsa regolabili per mezzo di una vite posta sulla testata. Per rendere meno rumoroso l'impatto del pistone sulla testata, questi cilindri sono inoltre dotati di un ammortizzatore meccanico.

CARATTERISTICHE GENERALI

Tipo di costruzione	a tiranti
Funzionamento	doppio effetto
Materiali	testate e pistone AL, stelo acciaio INOX AISI 420B rullato (Ø 160-200 mm) o acciaio cromato (Ø250-320 mm), dado stelo acciaio zincato, camicia AL anodizzato, tiranti e dadi tiranti acciaio zincato, guarnizioni stelo - pistone - ammortizzo NBR-PU anello raschiastelo OT
Fissaggio	a flangia anteriore - a flangia posteriore - piedini - cerniera intermedia - cerniera anteriore e posteriore
Corse min - max	10 ÷ 2500 mm
Temperatura d'esercizio	0°C + 80°C (con aria secca -20°C)
Pressione d'esercizio	1 + 10 bar
Velocità	10 ÷ 500 mm/sec (senza carico)
Fluido	aria filtrata, senza lubrificazione. Nel caso si utilizzasse aria lubrificata, si consiglia olio ISOVG32 e di non interrompere mai la lubrificazione.

TABELLA CORSE STANDARD PER CILINDRI SERIE 40

■ = doppio effetto

Ø	25	50	75	80	100	125	150	160	200	250	300	320	400	500
160		■		■	■		■		■		■		■	■
200		■			■				■		■			
250		■			■				■		■			
320		■			■				■		■			

ESEMPIO DI CODIFICA

40	M	2	L	160	A	0200	
40	SERIE						
M	VERSIONE M = standard, magnetico						
2	FUNZIONAMENTO 2 = doppio effetto, ammortizzato - anteriore e posteriore 3 = doppio effetto, non ammortizzato 4 = doppio effetto, ammortizzato - posteriore 5 = doppio effetto, ammortizzato - anteriore 6 = doppio effetto, stelo passante, ammortizzato - anteriore e posteriore 8 = doppio effetto, stelo passante, non ammortizzato					SIMBOLI PNEUMATICI CD09 CD08 CD10 CD11 CD13 CD12	
L	CARATTERISTICHE MATERIALI L = vedi caratteristiche generali pag. 1/1.10.01 T = tiranti INOX AISI 420B - dadi tiranti INOX AISI 303 C = stelo INOX AISI 303 rullato - dado stelo INOX AISI 304 U = stelo INOX AISI 303 rullato - dado stelo INOX AISI 304 - tiranti INOX AISI 420B - dadi tiranti INOX AISI 303 W = stelo INOX AISI 304 rullato - dado stelo INOX AISI 304 - tiranti INOX AISI 420B - dadi tiranti INOX AISI 303 N.B.: lo stelo dei cilindri alesaggio 250 e 320 mm è in acciaio C40 cromato.						
160	ALESAGGIO 160 = 160 mm - 200 = 200 mm - 250 = 250 mm - 320 = 320 mm						
A	TIPO COSTRUTTIVO A = standard F = cilindro con cerniera intermedia						
0200	CORSA (vedi tabella) = standard V = guarnizione stelo FKM W = tutte le guarnizioni in FKM +130°C C = verniciato PU. Colore: Grigio G = con raschiastelo OT (stelo INOX AISI 420B cromato, guarn. stelo NBR) [esclusi Ø 250 e 320] (_ _ _) = stelo più lungo di _ _ _ mm Note: La versione C è disponibile su richiesta. Per maggiori informazioni contattare i nostri tecnici. Le versioni W e C sono disponibili solo per i diametri 160 e 200.						

SIMBOLI PNEUMATICI

I simboli pneumatici indicati nell'ESEMPIO DI CODIFICA sono riportati di seguito.

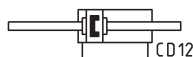
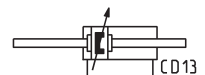
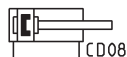
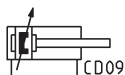

ACCESSORI DISPONIBILI PER LA SERIE 40



Spinotto Mod. S



Ancoraggio a cerniera combinata a 90° Mod. ZS



Supporto per cerniera intermedia Mod. BF

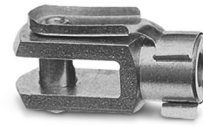

Forcella Mod. G

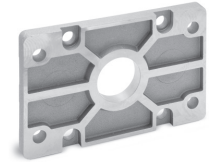

Ancoraggio a flangia post. o ant. Mod. D-E



Ancoraggio a cerniera intermedia Mod. F



Ancoraggio a piedini Mod. B



Snodo sferico Mod. GA

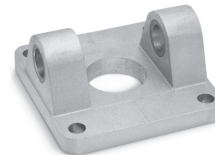

Ancoraggio femmina Mod. C-H



Dado stelo Mod. U

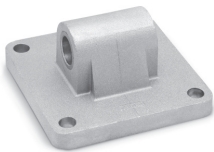

Ancoraggio maschio posteriore Mod. L



Snodo autoallineante Mod. GK

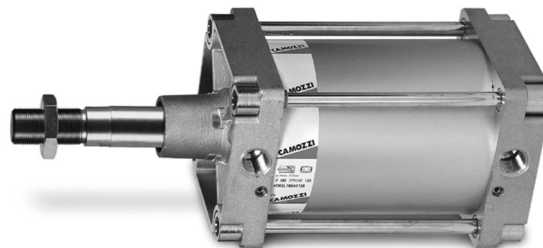
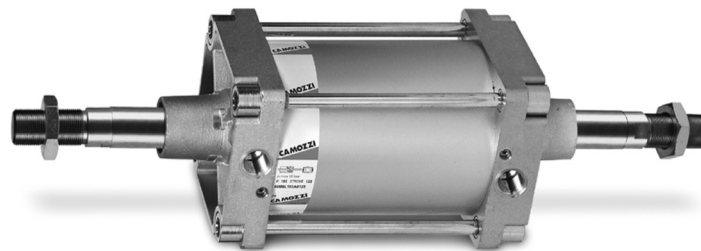

Tutti gli accessori sono forniti separatamente al cilindro, ad eccezione del dado stelo Mod. U. Per i sensori e per le staffette porta sensore vedere la sezione 1/9.

Cilindri Serie 40

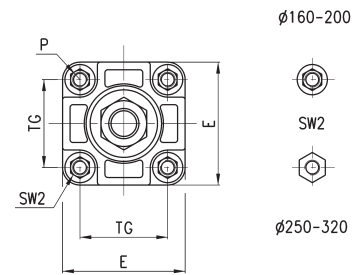
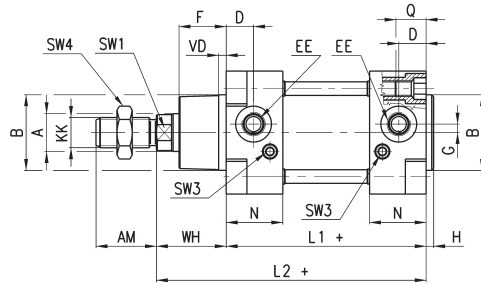

+ = sommare la corsa

INGOMBRI

ϕ	A	KK	B	D	G	F	AM	H	EE	WH	L1+	L2+	VD	N	P	Q	TG	E	SW1	SW2	SW3	SW4	Corsa	Ammortizzo anteriore/posteriore
160	40	M36x2	65	25	12	53.5	72	6	G3/4	80	180	260	6	45	M16	26	140	176	36	17	4	55		29 / 36
200	40	M36x2	75	25	12	63.5	72	6	G3/4	95	180	275	6	45	M16	26	175	216	36	17	4	55		44 / 42
250	50	M42x2	90	31	12	67	84	10	G1	105	200	305	6	60	M20	30	220	270	46	36	4	65		50 / 50
320	63	M48x2	110	31	12	83	96	10	G1	120	220	340	12	55,5	M24	30	270	340	55	41	-	75		56 / 56

Cilindri Serie 40 - stelo passante

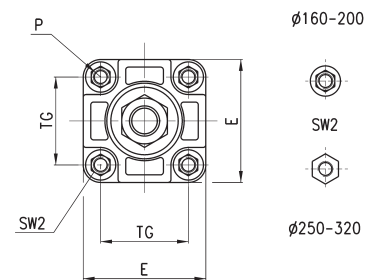
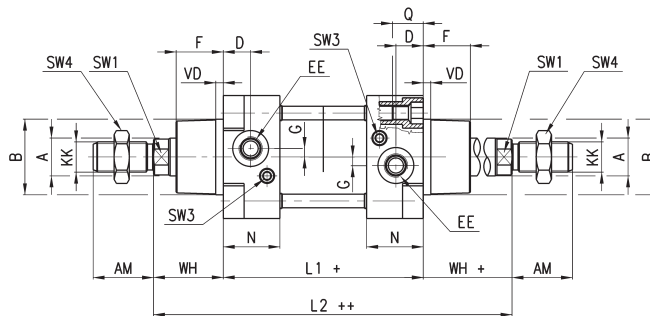
 + = sommare la corsa una volta
 ++ = sommare la corsa due volte

INGOMBRI

ϕ	A	KK	B	D	G	F	AM	EE	WH	L1+	L2++	VD	N	P	Q	TG	E	SW1	SW2	SW3	SW4	Corsa	Ammortizzo anteriore/posteriore
160	40	M36x2	65	25	12	53.5	72	G3/4	80	180	340	6	45	M16	26	140	176	36	17	4	55		29 / 36
200	40	M36x2	75	25	12	63.5	72	G3/4	95	180	370	6	45	M16	26	175	216	36	17	4	55		44 / 42
250	50	M42x2	90	31	12	67	84	G1	105	200	410	6	60	M20	30	220	270	46	36	4	65		50 / 50
320	63	M48x2	110	31	12	83	96	G1	120	200	?	12	55,5	M24	30	270	340	55	41	-	75		56 / 56

Cilindri Serie 40 con cerniera Mod. F montata



+ = sommare la corsa
 + 1/2 = sommare metà corsa

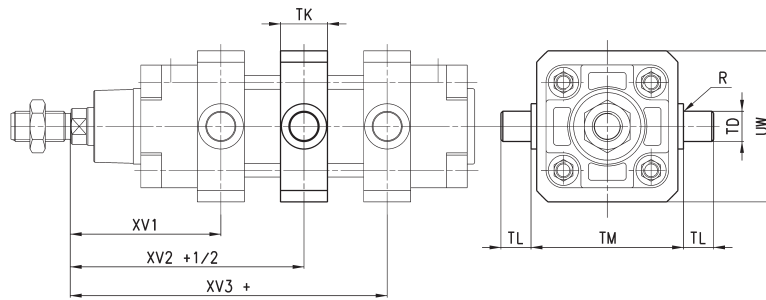

INGOMBRI										
Ø	XV1	XV2+ 1/2	XV3+	TM	TK	TD	TL	UW	R	NOTA
160	145	170	195	200	40	32	32	190	2	
200	160	185	210	250	40	32	32	240	2	
250	185	205	225	320	50	40	40	300	-	montaggio con 4 tiranti filettati
320	210,5	230	249,5	400	70	50	50	400	-	montaggio con 4 tiranti filettati

Ancoraggio a piedini Mod. B

La fornitura comprende:
 - 2 piedini in acciaio verniciato nero (cataforesi)
 - 4 viti zincate bianche

Per i Ø 250 e 320 zincatura bianca



+ = sommare la corsa

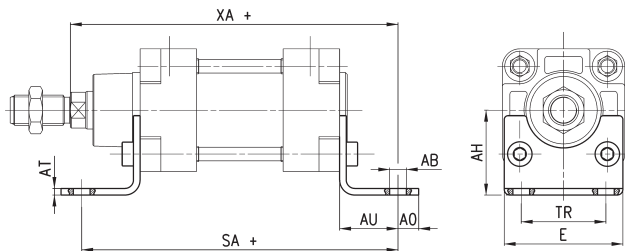

INGOMBRI

Mod.	Ø	AT	SA+	XA+	TR	E	∅AB	AH	AO	AU
B-41-160	160	10	300	320	115	175	18.5	115	25	60
B-41-200	200	12	320	345	135	238	24	135	35	70
B-41-250	250	14	350	380	165	270	26	165	25	75
B-41-320	320	20	390	425	200	353	35	200	45	85

Ancoraggio a flangia posteriore o anteriore Mod. D-E

La fornitura comprende:
 - 1 flangia
 - 4 viti

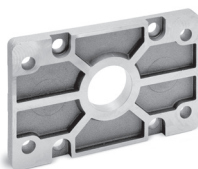

+ = sommare la corsa

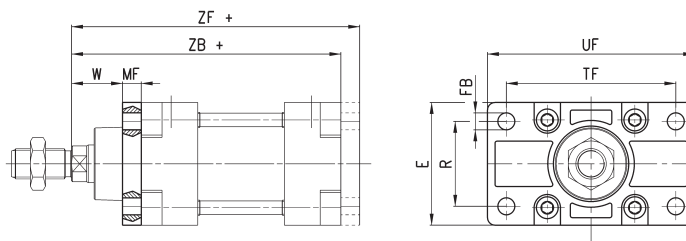

INGOMBRI

Mod.	Ø	W	MF	ZB+	TF	R	UF	E	∅FB	ZF+	Materiale
D-E-41-160	160	60	20	260	230	115	276	175	18	280	alluminio
D-E-41-200	200	70	25	275	270	135	312	215	22	300	alluminio
D-E-41-250	250	80	25	305	330	165	400	285	26	330	acciaio zincato
D-E-41-320	320	90	30	340	400	200	470	334	33	370	acciaio Inox 304

Ancoraggio a cerniera femmina posteriore o anteriore Mod. C-H

La fornitura comprende:
 - 1 cerniera femmina in alluminio
 - 4 viti

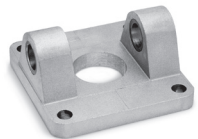

+ = sommare la corsa

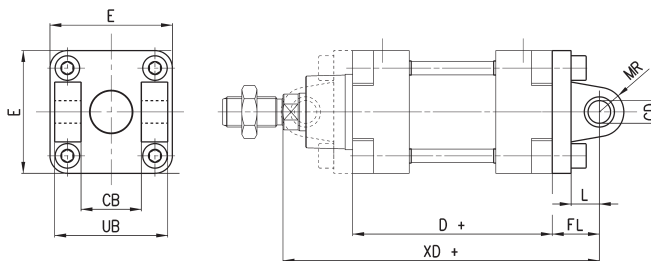

INGOMBRI

Mod.	Ø	∅CD	L	FL	D+	XD+	MR	E	CB	UB
C-H-41-160	160	30	35	55	180	315	30	175	90	170
C-H-41-200	200	30	35	60	180	335	30	215	90	170
C-H-41-250	250	40	45	70	200	375	40	270	110	200
C-H-41-320	320	45	50	80	220	420	45	350	120	220

Ancoraggio a cerniera maschio posteriore Mod. L

La fornitura comprende:
 - 1 cerniera maschio in alluminio *
 - 4 viti

* Per il Ø 320 acciaio verniciato nero (cataforesi)

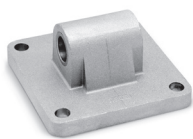

+ = sommare la corsa

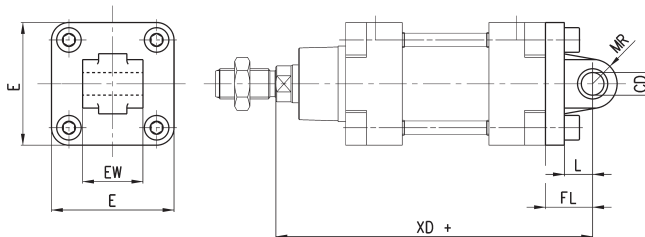

INGOMBRI								
Mod.	Ø	øCD	L	FL	XD+	MR	E	EW
L-41-160	160	30	35	55	315	30	175	90
L-41-200	200	30	35	60	335	30	215	90
L-41-250	250	40	45	70	375	40	270	110
L-41-320	320	45	50	80	420	45	350	110

Ancoraggio a cerniera intermedia Mod. F

Materiale:
 - acciaio zincato (Ø 160 e 200)
 - ghisa verniciata (Ø 250 e 320)



+ = sommare la corsa

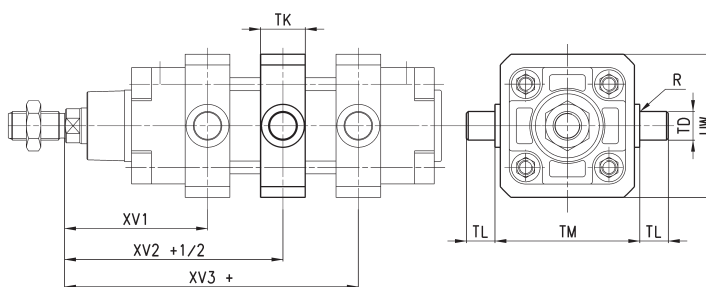

INGOMBRI											
Mod.	Ø	XV1	XV + 1/2	XV3 +	TM	TK	øTD	TL	UW	R	NOTA
F-160	160	145	170	195	200	40	32	32	190	2	
F-200	200	160	185	210	250	40	32	32	240	2	
F-250	250	185	205	225	320	50	40	40	296	-	montaggio con 4 tiranti filettati
F-320	320	210,5	230	249,5	400	70	50	50	400	-	montaggio con 4 tiranti filettati

Ancoraggio a cerniera combinata a 90° Mod. ZS*

* Non a norma

La fornitura comprende 1 ancoraggio a 45° in alluminio

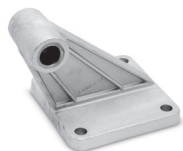

+ = sommare la corsa

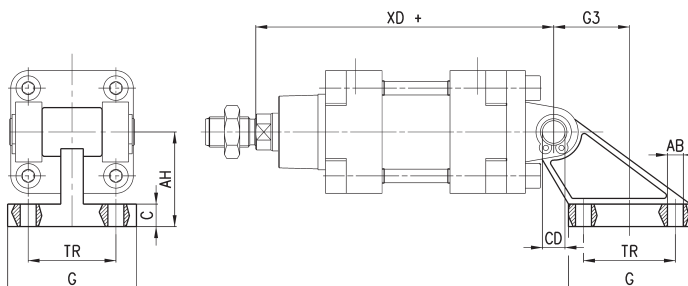

INGOMBRI									
Mod.	Ø	TR	øAB	AH	C	G	øCD	XD +	G3
ZS-160	160	140	18	140	20	180	30	315	105
ZS-200	200	175	18	140	25	220	30	335	125

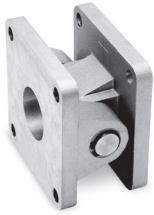
Combinazione di accessori Mod. C+L+S

+ = sommare la corsa

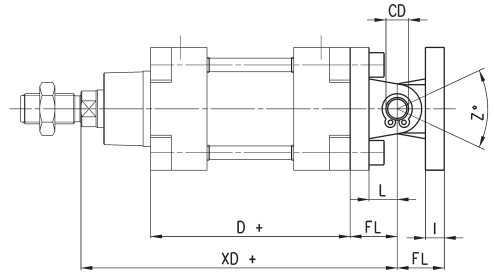
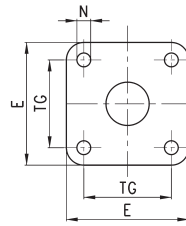
INGOMBRI

Mod.	∅	E	TG	∅N	D+	XD+	∅CD	L	FL	I	Z° (max)
C+L+S	160	175	140	17	180	315	30	35	55	20	25
C+L+S	200	215	175	17	180	335	30	35	60	25	20
C+L+S	250	270	220	25	200	375	40	45	70	25	33
C+L+S	320	350	270	30	220	420	40	50	80	30	30

Supporto per cerniera intermedia Mod. BF

La fornitura comprende 2 supporti in alluminio

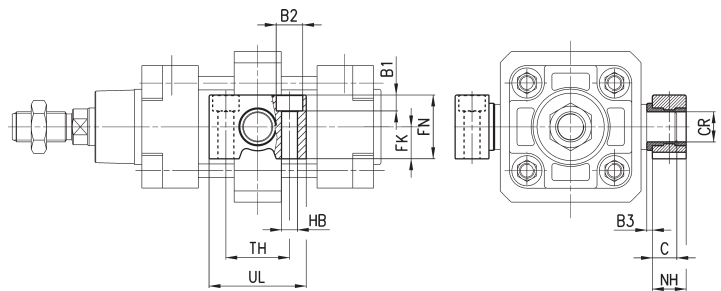
INGOMBRI

Mod.	∅	∅CR	NH	C	B3	TH	UL	FK	FN	B1	∅B2	∅HB
BF-160-200	160-200	32	35	17,5	4	60	92	30	60	16	26	18

Forcella Mod. G

ISO 8140

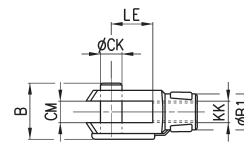
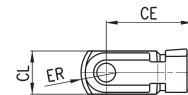
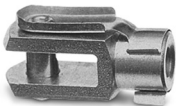
 Materiale:
- acciaio zincato

INGOMBRI

Mod.	∅	∅CK	LE	CM	CL	ER	CE	KK	B	∅B1
G-160-200	160-200	35	72	35	70	44	144	M36x2	92	60
G-250	250	40	84	40	85	-	168	M42x2	96	70
G-320	320	50	96	50	90	73	192	M48x2	120	80

Snodo sferico Mod. GA

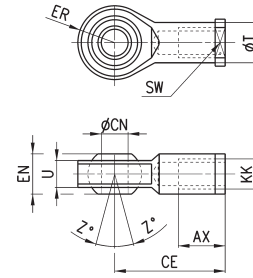
ISO 8139



INGOMBRI											
Mod.	Ø	øCN	U	EN	ER	AX	CE	KK	ØT	Z	SW
GA-160-200	160-200	35	28	43	40	56	125	M36x2	46	6	50
GA-250	250	40	33	49	-	60	142	M42x2	55	17	55
GA-320	320	50	45	60	58.5	65	160	M48x2	65	12	65

Spinotto Mod. S

La fornitura comprende:
 - 1 spinotto
 - 2 seeger in acciaio

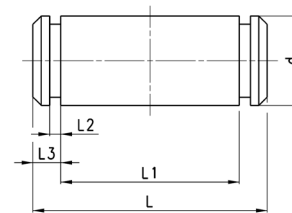

INGOMBRI							
Mod.	Ø	d	L	L1	L2	L3	Materiale
S-160-200	160-200	30	180.5	172	1.6	4.25	acciaio Inox 303
S-250	250	40	210	202	1.85	4.5	acciaio zincato
S-320	320	45	236	222	1.85	7	acciaio zincato

Dado stelo Mod. U

UNI EN ISO 4035
 Materiale: Acciaio zincato

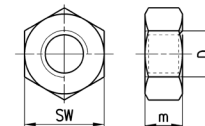

INGOMBRI				
Mod.	Ø	D	m	SW
U-160-200	160-200	M36x2	14	55
U-250	250	M42x2	16	65
U-320	320	M48x2	24	75

Snodo autoallineante Mod. GK

Materiale: Acciaio zincato

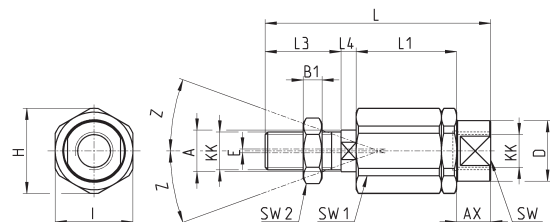

INGOMBRI																	
Mod.	Ø	KK	L	L1	L3	L4	øA	øD	H	I	SW	SW1	SW2	B1	AX	Z	E
GK-160-200	160-200	M36x2	190	77	72	15.5	39	57	75	70	54	32	55	14	68	4	2