

# Cilindri in acciaio INOX Serie 90

Semplice e doppio effetto, ammortizzati, magnetici  
 ø 32, 40, 50, 63, 80, 100 e 125 mm



- » Conformi alla normativa ISO 15552 e alle precedenti norme DIN/ISO 6431 - VDMA 24562
- » Design pulito
- » Acciaio inossidabile AISI 316
- » Ammortizzatore di fine corsa

I cilindri della Serie 90 possono essere impiegati nell'industria off-shore, navale, farmaceutica, nucleare e alimentare.

Questa serie di cilindri è normalmente fornita con ammortizzatori di fine corsa regolabili per mezzo di una vite posta sulla testata. Per rendere meno rumoroso l'impatto del pistone sulla testata, questi cilindri sono inoltre dotati di un ammortizzatore meccanico.

## CARATTERISTICHE GENERALI

<b>Costruzione</b>	tiranti
<b>Funzionamento</b>	semplice e doppio effetto
<b>Materiali</b>	- testate, tubo e stelo in acciaio AISI 316 - guarnizioni in NBR - elemento di guida in materiale plastico, grasso con certificazione NSF H1
<b>Fissaggio</b>	disponibili vari tipi di fissaggi applicabili al cilindro
<b>Corse min - max</b>	25 + 800 mm
<b>Temperatura d'esercizio</b>	0°C + 80°C (con aria secca -20 °C)
<b>Pressione d'esercizio</b>	1 + 10 bar
<b>Velocità</b>	10 + 1000 mm/sec (senza carico)
<b>Fluido</b>	aria filtrata, senza lubrificazione. Nel caso si utilizzasse aria lubrificata, si consiglia olio ISOVG32 e di non interrompere mai la lubrificazione.

**TABELLA CORSE STANDARD PER CILINDRI SERIE 90**

- = Semplice effetto
- ✕ = Doppio effetto

**CORSE STANDARD**

Ø	25	50	80	100	125	150	160	200	250	300	320	400	500
32	✕•	✕•	✕	✕	✕	✕	✕	✕	✕	✕	✕	✕	✕
40	✕•	✕•	✕	✕	✕	✕	✕	✕	✕	✕	✕	✕	✕
50	✕•	✕•	✕	✕	✕	✕	✕	✕	✕	✕	✕	✕	✕
63	✕•	✕•	✕	✕	✕	✕	✕	✕	✕	✕	✕	✕	✕
80	✕•	✕•	✕	✕	✕	✕	✕	✕	✕	✕	✕	✕	✕
100	✕•	✕•	✕	✕	✕	✕	✕	✕	✕	✕	✕	✕	✕
125		✕•	✕	✕	✕	✕	✕	✕	✕	✕	✕	✕	✕

**ESEMPIO DI CODIFICA**

<b>90</b>	<b>M</b>	<b>2</b>	<b>A</b>	<b>050</b>	<b>A</b>	<b>0200</b>	
-----------	----------	----------	----------	------------	----------	-------------	--

<b>90</b>	SERIE		
<b>M</b>	VERSIONE M = standard, magnetico		
<b>2</b>	FUNZIONAMENTO 1 = semplice effetto, molla anteriore 2 = doppio effetto, ammortizzato anteriore e posteriore 6 = doppio effetto, stelo passante, ammortizzato anteriore e posteriore		SIMBOLI PNEUMATICI CS06 CD09 CD13
<b>A</b>	CARATTERISTICHE MATERIALI A = acciaio inossidabile AISI 316 - guarnizioni NBR V = acciaio inossidabile AISI 316 - tutte le guarnizioni in FKM (150°C)		
<b>050</b>	ALESAGGIO 032 = 32 mm - 040 = 40 mm - 050 = 50 mm - 063 = 63 mm 080 = 80 mm - 100 = 100 mm - 125 = 125 mm		
<b>A</b>	TIPO COSTRUTTIVO A = standard con dado stelo U		
<b>0200</b>	CORSA (vedi tabella)		
	= standard V = guarnizione stelo in FKM		

**SIMBOLI PNEUMATICI**

I simboli pneumatici indicati nell'ESEMPIO DI CODIFICA sono riportati di seguito.

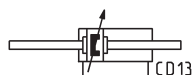
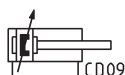

**ACCESSORI CILINDRI INOX SERIE 90**
**1**

MOVIMENTO

 Ancoraggio a piedini  
Mod. B

 Ancoraggio a flangia ant.  
e post. Mod. D-E

 Ancoraggio a cerniera  
femmina post. Mod. C-H

 Ancor. a cerniera masc.  
chio post. Mod. L

 Ancor. a cern. femm.  
post. stretta Mod. CR

 Ancor. a cern. masc. con  
snodo sferico Mod. R

 Ancor. a cern. masc. 90°  
con snodo sf. Mod. ZCR

 Supp. 90° per cerniera  
femmina Mod. ZC

Forcella Mod. G-90



Spinotto Mod. S-90

 Spinotto antirotazione  
Mod. SR-90

 Snodo sferico  
Mod. GA-90

Dado stelo Mod. U-90



Tutti gli accessori sono forniti separatamente al cilindro fatta eccezione del dado stelo Mod. U

Cilindri Serie 90



+ = sommare la corsa

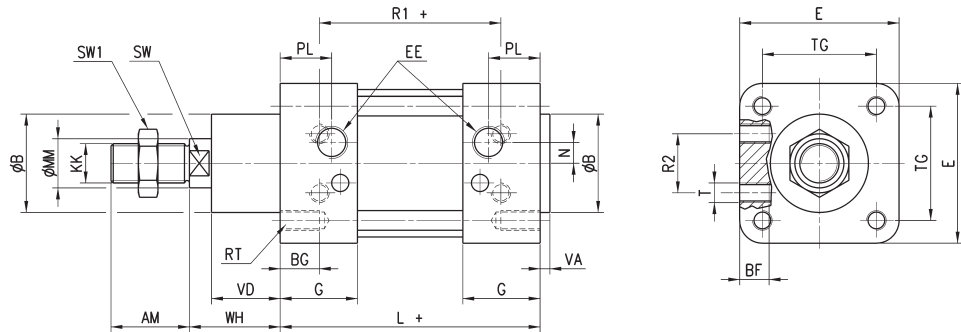

INGOMBRI

Ø	AM	B	BF	BG	E	EE	G	KK	L	MM	N	PL	RT	R1	R2	SW	SW1	T	TG	VA	VD	WH
32	22	30	10	16	45	G1/8	28	M10x1.25	94	12	4.5	14	M6	64	16	10	17	M5	32.5	4	20	26
40	24	35	10	16	55	G1/4	31.5	M12x1.25	105	16	5.5	16	M6	70	21	13	19	M6	38	4	22	30
50	32	40	12	16	65	G1/4	31.5	M16x1.5	106	20	8.5	21	M8	74	24	17	24	M8	46.5	4	28	37
63	32	45	12	16	80	G3/8	35	M16x1.5	121	20	8.5	22	M8	85	33	17	24	M8	56.5	4	28	37
80	40	45	15	16	95	G3/8	36	M20x1.5	128	25	8.5	23	M10	92	34	21	30	M10	72	4	34	46
100	40	55	15	16	115	G1/2	41	M20x1.5	138	25	10	26	M10	100	58	21	30	M10	89	4	38	51
125	54	60	24	20	140	G1/2	45	M27x2	160	32	12.5	30	M12	110	65	27	41	M12	110	5	50	65

Cilindri Serie 90 - stelo passante



+ = sommare la corsa  
++ = sommare la corsa due volte

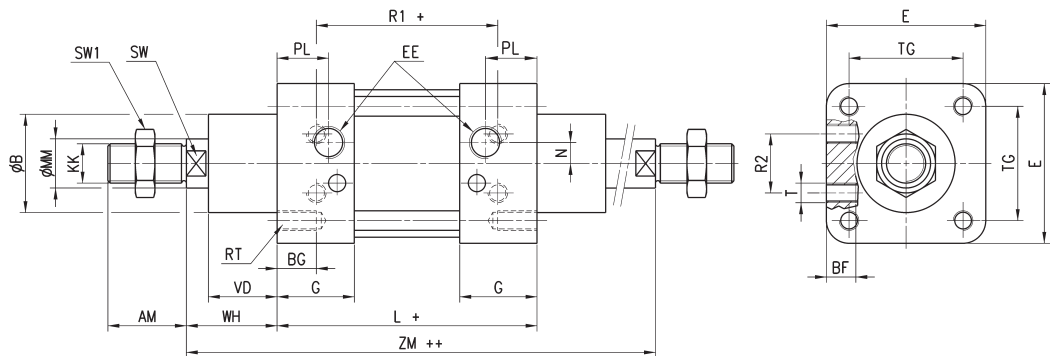

INGOMBRI

Ø	AM	B	BF	BG	E	EE	G	KK	L	MM	N	PL	RT	R1	R2	SW	SW1	T	TG	VD	WH	ZM
32	22	30	10	16	45	G1/8	28	M10x1.25	94	12	4.5	14	M6	64	16	10	17	M5	32.5	20	26	146
40	24	35	10	16	55	G1/4	31.5	M12x1.25	105	16	5.5	16	M6	70	21	13	19	M6	38	22	30	165
50	32	40	12	16	65	G1/4	31.5	M16x1.5	106	20	8.5	21	M8	74	24	17	24	M8	46.5	28	37	180
63	32	45	12	16	80	G3/8	35	M16x1.5	121	20	8.5	22	M8	85	33	17	24	M8	56.5	28	37	195
80	40	45	15	16	95	G3/8	36	M20x1.5	128	25	8.5	23	M10	92	34	21	30	M10	72	34	46	220
100	40	55	15	16	115	G1/2	41	M20x1.5	138	25	10	26	M10	100	58	21	30	M10	89	38	51	240
125	54	60	24	20	140	G1/2	45	M27x2	160	32	12.5	30	M12	110	65	27	41	M12	110	50	65	290

**Ancoraggio a piedini Mod. B**

Materiale: Acciaio Inox 316

 La fornitura comprende:  
 N° 2 piedini  
 N° 4 viti

+ = sommare la corsa

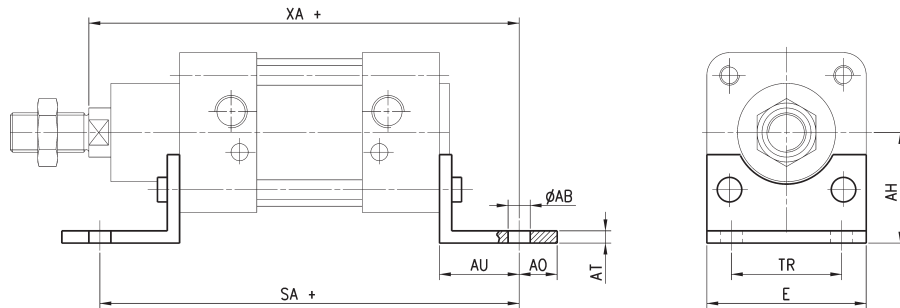

INGOMBRI										
Mod.	Ø	ØAB	AH	AO	AT	AU	E	TR	SA+	XA+
<b>B-90-32</b>	32	7	32	11	4	24	45	32	142	144
<b>B-90-40</b>	40	9	36	8	4	28	52	36	161	163
<b>B-90-50</b>	50	9	45	15	5	32	65	45	170	175
<b>B-90-63</b>	63	9	50	13	5	32	75	50	185	190
<b>B-90-80</b>	80	12	63	14	6	41	95	63	210	215
<b>B-90-100</b>	100	14	75	16	6	41	115	75	220	230
<b>B-90-125</b>	125	16	90	25	8	45	140	90	250	270

**Ancoraggio a flangia anteriore e posteriore Mod. D-E**

Materiale: Acciaio Inox 316

 La fornitura comprende:  
 N° 1 flangia  
 N° 4 viti

+ = sommare la corsa

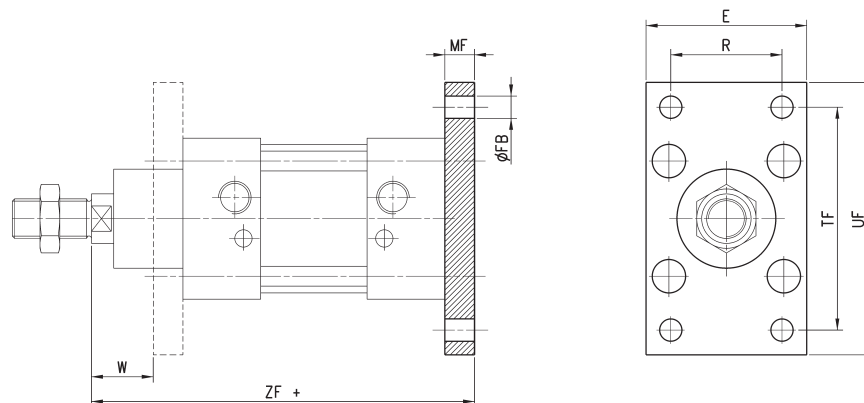

INGOMBRI									
Mod.	Ø	E	ØFB	MF	TF	UF	W	ZF+	R
<b>D-E-90-32</b>	32	45	7	10	64	80	16	130	32
<b>D-E-90-40</b>	40	52	9	10	72	90	20	145	36
<b>D-E-90-50</b>	50	65	9	12	90	110	25	155	45
<b>D-E-90-63</b>	63	75	9	12	100	120	25	170	50
<b>D-E-90-80</b>	80	95	12	15	126	150	30	190	63
<b>D-E-90-100</b>	100	115	14	15	150	170	35	205	75
<b>D-E-90-125</b>	125	140	16	20	180	205	45	245	90

Ancoraggio a cerniera femmina posteriore Mod. C-H

Materiale: Acciaio Inox 316



La fornitura comprende:  
N° 1 cerniera femmina  
N° 4 viti

+ = sommare la corsa

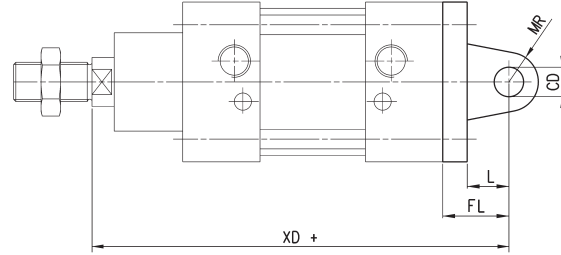
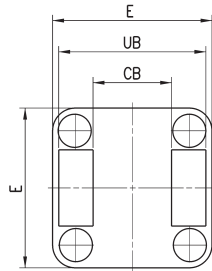

INGOMBRI									
Mod.	Ø	CB	CD	E	FL	L	MR	UB	XD+
C-H-90-32	32	26	10	45	22	12	10	45	142
C-H-90-40	40	28	12	55	25	15	12	52	161
C-H-90-50	50	32	12	65	27	17	12	60	170
C-H-90-63	63	40	16	75	32	20	16	70	185
C-H-90-80	80	50	16	95	36	22	16	90	210
C-H-90-100	100	60	20	115	41	25	20	110	230
C-H-90-125	125	70	25	140	50	30	25	130	275

Ancoraggio a cerniera maschio posteriore Mod. L

Materiale: Acciaio Inox 316



La fornitura comprende:  
N° 1 cerniera maschio  
N° 4 viti

+ = sommare la corsa

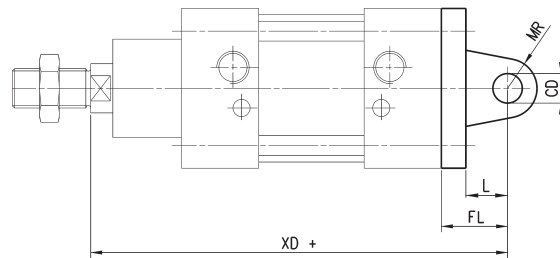
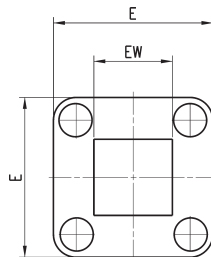

INGOMBRI								
Mod.	Ø	EW	CD	E	FL	L	MR	XD+
L-90-32	32	26	10	45	22	12	10	142
L-90-40	40	28	12	55	25	15	12	161
L-90-50	50	32	12	65	27	17	12	170
L-90-63	63	40	16	75	32	20	16	185
L-90-80	80	50	16	95	36	22	16	210
L-90-100	100	60	20	115	41	25	20	230
L-90-125	125	70	25	140	50	30	25	275

**Ancoraggio a cerniera femmina posteriore stretta Mod. CR**

Materiale: Acciaio Inox 316

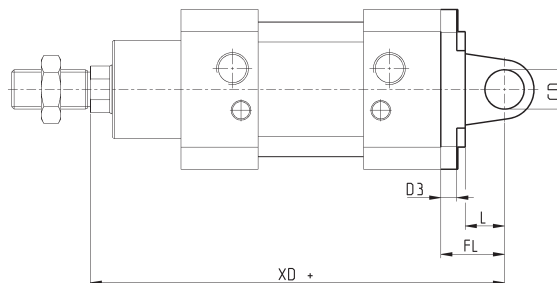
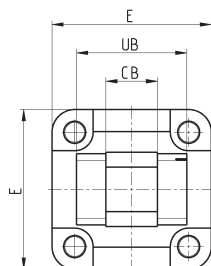
 La fornitura comprende:  
 N° 1 cerniera femmina  
 N° 4 viti

+ = sommare la corsa

**DIMENSIONI**

Mod.	Ø	CB	CD	E	FL	L	UB	XD	D3
CR-90-32	32	14	10	45	22	12	34	142	5.5
CR-90-40	40	16	12	55	25	25	40	161	5.5
CR-90-50	50	21	16	65	27	27	45	170	6.5
CR-90-63	63	21	16	75	32	32	51	185	6.5
CR-90-80	80	25	20	95	36	36	65	210	10
CR-90-100	100	25	20	114	41	41	75	230	10
CR-90-125	125	37	30	140	50	50	97	275	10

**Ancoraggio a cerniera maschio con snodo sferico Mod. R**

Materiale: Acciaio Inox 316

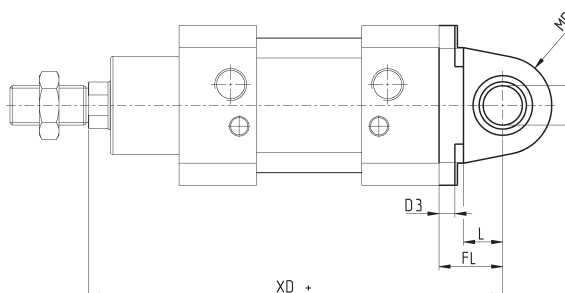
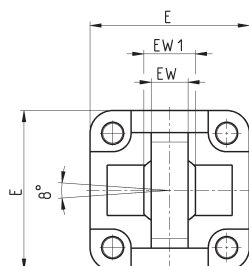
 La fornitura comprende:  
 N° 1 cerniera maschio  
 N° 4 viti

+ = sommare la corsa

**DIMENSIONI**

Mod.	Ø	EW	EW1	CD	E	FL	L	MR	XD	D3
R-90-32	32	10.5	14	10	45	22	12	15	142	5.5
R-90-40	40	12	16	12	55	25	15	18	161	5.5
R-90-50	50	15	21	16	65	27	17	20	170	6.5
R-90-63	63	15	21	16	75	32	20	23	185	6.5
R-90-80	80	18	25	20	95	36	22	27	210	10
R-90-100	100	18	25	20	115	41	25	30	230	10
R-90-125	125	25	37	30	140	50	30	40	275	10

**Ancoraggio a cerniera maschio a 90° con snodo sferico Mod. ZCR**

Materiale: Acciaio Inox 316



La fornitura comprende:  
N° 1 cerniera maschio  
N° 4 viti

+ = sommare la corsa

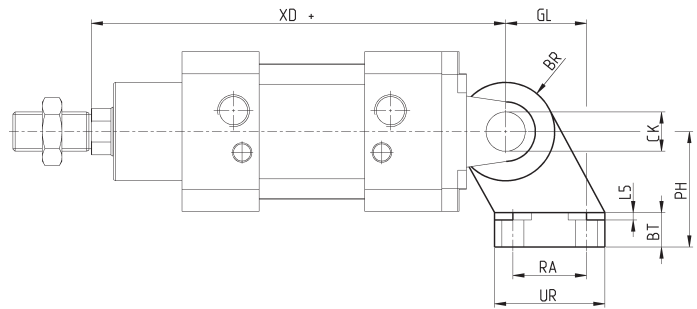
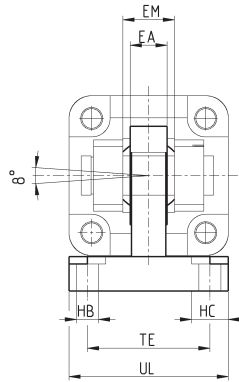

INGOMBRI																	
Mod.	Ø	UL	TE	EA	EM	XD	GL	BR	CK	PH	L5	BT	HB	RA	UR	HC	
ZCR-90-32	32	51	38	10.5	14	142	21	15	10	32	1.5	10	6.6	18	31	11	
ZCR-90-40	40	54	41	12	16	160	24	18	12	36	1.5	10	6.6	22	35	11	
ZCR-90-50	50	65	50	15	21	170	33	20	16	45	1.5	12	9	30	45	15	
ZCR-90-63	63	67	52	15	21	190	37	23	16	50	1.5	12	9	35	50	15	
ZCR-90-80	80	86	66	18	25	210	47	27	20	63	2.5	14	11	40	60	18	
ZCR-90-100	100	96	76	18	25	230	55	30	20	71	2.5	15	11	50	70	18	
ZCR-90-125	125	124	94	25	37	275	70	40	30	90	3	20	13.5	60	90	20	

**Supporto 90° per cerniera femmina Mod. ZC**

Materiale: Acciaio Inox 316



La fornitura comprende:  
N° 1 supporto maschio

+ = sommare la corsa

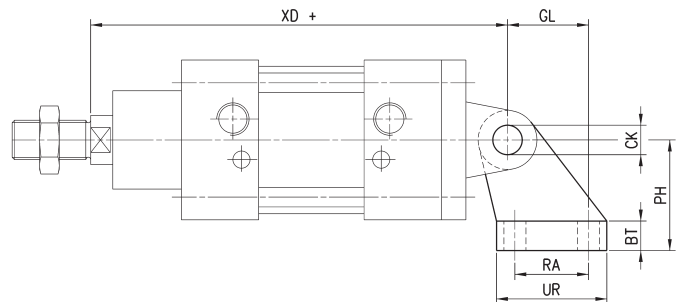
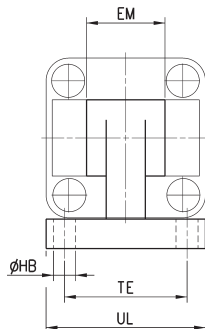

INGOMBRI													
Mod.	Ø	BT	CK	EM	GL	ØHB	PH	RA	TE	UL	UR	XD+	
ZC-90-32	32	8	10	26	21	6,6	32	18	38	51	31	142	
ZC-90-40	40	10	12	28	24	6,6	36	22	41	54	35	161	
ZC-90-50	50	12	12	32	33	9	45	30	50	65	45	170	
ZC-90-63	63	12	16	40	37	9	50	35	52	67	50	185	
ZC-90-80	80	14	16	50	47	11	63	40	66	86	60	210	
ZC-90-100	100	15	20	60	55	11	71	50	76	96	70	230	
ZC-90-125	125	20	25	70	70	14	90	60	94	124	90	275	



**Forcella Mod. G-90**

ISO 8140

Materiale: Acciaio Inox 303

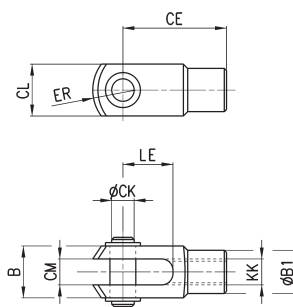
**DIMENSIONI**

Mod.	Ø	ØCK	LE	CM	CL	ER	CE	KK	B	ØB1
<b>G-90-25-32</b>	32	10	20	10	20	12	40	M10x1,25	26	18
<b>G-90-40</b>	40	12	24	12	24	14	48	M12x1,25	31	20
<b>G-90-50-63</b>	50-63	16	32	16	32	19	64	M16x1,5	39	26
<b>G-90-80-100</b>	80-100	20	40	20	40	25	80	M20x1,5	50	34
<b>G-90-125</b>	125	30	54	30	55	38	110	M27x2	67	48

**Spinotto Mod. S-90**

Materiale: Acciaio Inox 303

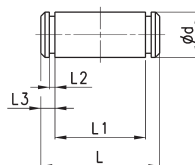
**INGOMBRI**

Mod.	Ø	Ød	L	L1	L2	L3
<b>S-90-32</b>	32	10	53	46	1,1	3
<b>S-90-40</b>	40	12	60	53	1,1	3
<b>S-90-50</b>	50	12	68	61	1,1	3
<b>S-90-63</b>	63	16	78	71	1,1	3
<b>S-90-80</b>	80	16	98	91	1,1	3
<b>S-90-100</b>	100	20	118	111	1,3	5
<b>S-90-125</b>	125	25	139	132	1,3	4,2

### Spinotto antirotazione Mod. SR-90

La fornitura comprende:  
 N° 1 spinotto antirotazione  
 (acciaio Inox 316)  
 N° 1 seeger (acciaio)

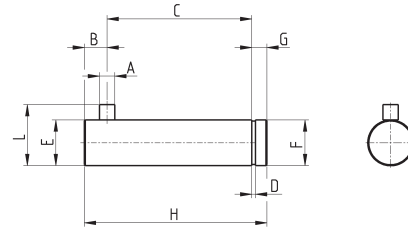

#### INGOMBRI

Mod.	Ø	A	B	C	D	E	F	G	H	L
<b>SR-90-32</b>	32	3	4.5	32.5	1.1	10	9.6	4	41	14
<b>SR-90-40</b>	40	4	6	38	1.1	12	11.5	4	48	46
<b>SR-90-50</b>	50	4	6	43	1.1	16	15.2	5	54	20
<b>SR-90-63</b>	63	4	6	49	1.1	16	15.2	5	60	20

### Snodo sferico stelo Mod. GA-90

ISO 8139

Materiali:  
 - supporto in Acciaio INOX 304  
 - anello sferico in Acciaio INOX 420  
 - boccia in bronzo sinterizzato

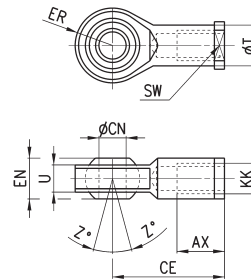

#### INGOMBRI

Mod.	Ø	ØCN	U	EN	ER	AX	CE	KK	ØT	Z	SW
<b>GA-90-32</b>	32	10	10,5	14	14	20	43	M10x1,25	15	6,5	17
<b>GA-90-40</b>	40	12	12	16	16	22	50	M12x1,25	17,5	6,5	19
<b>GA-90-50-63</b>	50-63	16	15	21	21	28	64	M16x1,5	22	7,5	22
<b>GA-90-80-100</b>	80-100	20	18	25	21	33	77	M20x1,5	27,5	7	30
<b>GA-90-125</b>	125	30	25	35	35	51	110	M27x2	40	7,5	41

### Dado stelo Mod. U-90

UNI EN ISO 4035  
 Materiale: Acciaio Inox 304

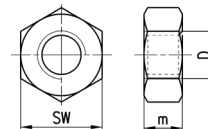

#### INGOMBRI

Mod.	Ø	D	m	SW
<b>U-90-25-32</b>	32	M10x1,25	6	17
<b>U-90-40</b>	40	M12x1,25	7	19
<b>U-90-50-63</b>	50-63	M16x1,5	8	24
<b>U-90-80-100</b>	80-100	M20x1,5	9	30
<b>U-90-125</b>	125	M27x2	12	41